

Cushing-Taylor
DC04-253-18
18 cm/7"



Oehler
DC04-255-14 = 14 cm/5 1/2"
DC04-255-16 = 16 cm/6 1/2"
DC04-255-18 = 18 cm/7"
DC04-255-20 = 20 cm/8"
DC04-255-25 = 25 cm/10"
DC04-255-30 = 30 cm/12"



DeBailey

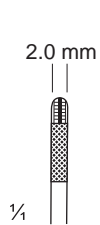

DC04-257-15
15cm/6"

DC04-259-20
20cm/8"

DC04-261-24
24cm/9 1/2"



DC04-263-15
15cm/6"

DC04-265-20
20cm/8"

DC04-267-24
24cm/9 1/2"

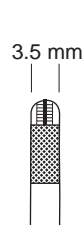

DC04-269-20
20cm/8"

DC04-271-24
24cm/9 1/2"

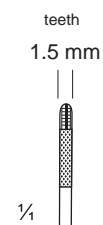

DC04-273-15
15cm/6"

DC04-275-20
20cm/8"

DC04-277-25
25cm/10"



DeBailey

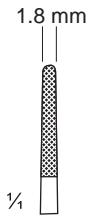
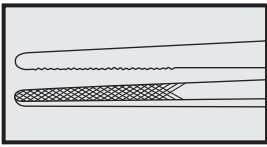

DC04-279-14
14cm/5 1/2"

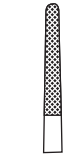

DC04-279-17
17cm/6 3/4"



DC04-279-20
20cm/8"



DC04-279-25
25cm/10"

with dissector end

Potts-Nevins

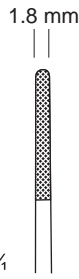

DC04-281-18
18cm/7"

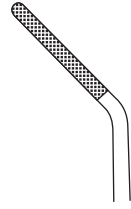

DC04-283-18
18cm/7"

Cushing

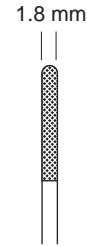

DC04-285-18
18cm/7"

Lucae

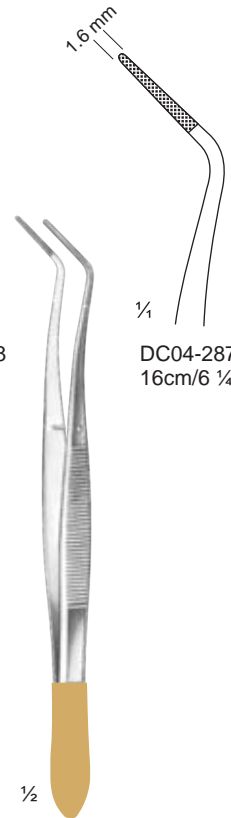

DC04-287-16
16cm/6 1/4"

Meriam

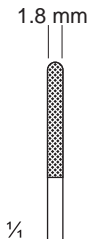

DC04-289-13
13cm/5"



DC04-291-14
14cm/5 1/2"



DC04-293-16
16cm/6 1/4"



DC04-295-18
18cm/7"



DC04-297-20
20cm/8"



DC04-299-25
25cm/10"

Standard

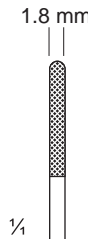

DC04-301-17
17cm/6 3/4"

Potts-Smit
with dissector end

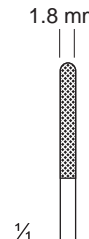

DC04-303-18
18cm/7"

Potts-Smit
with dissector end

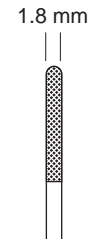

DC04-305-20
20cm/8"

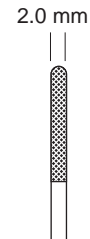

DC04-307-25
25cm/10"

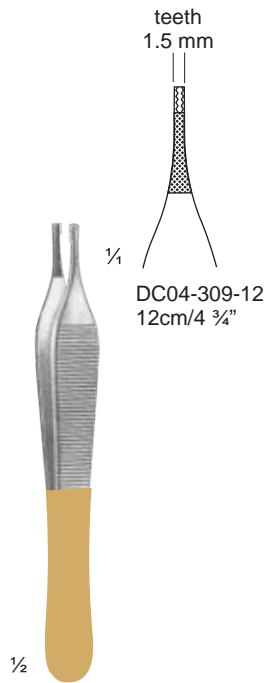
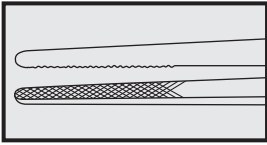

Adson-Brown

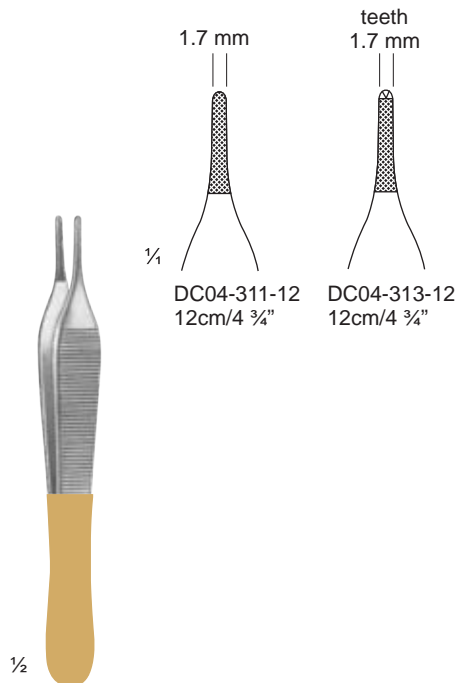

Adson

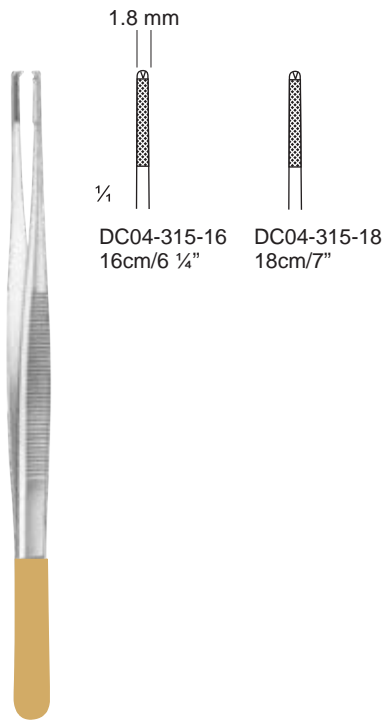

Semken

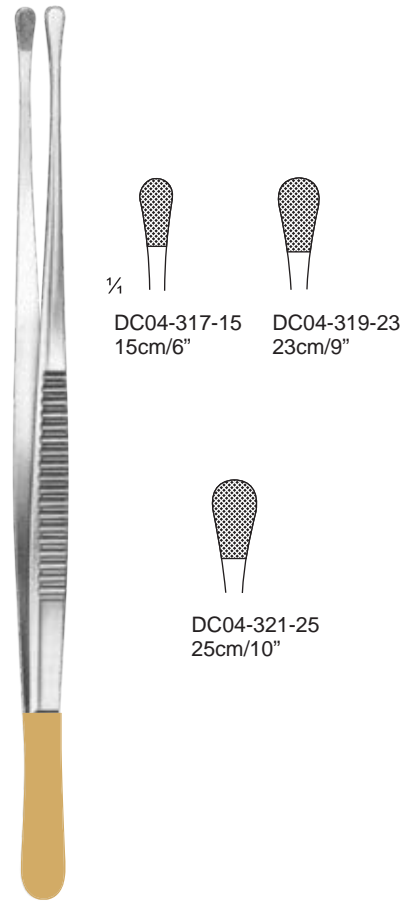

Wangenstein

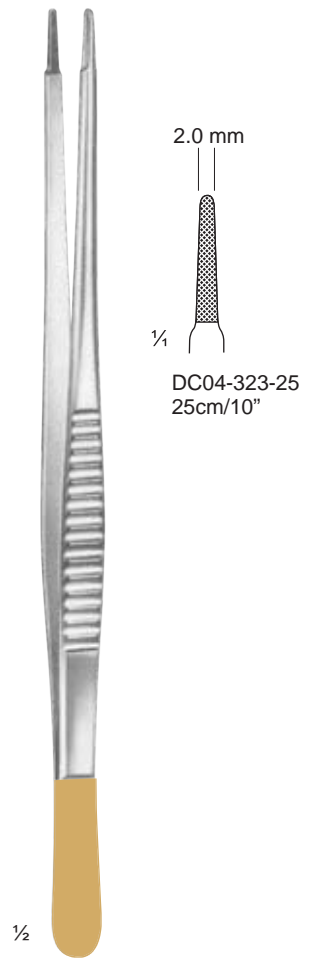

Evans